



SERIE - SERIES

PN

[www.malcleanse.co.uk](http://www.malcleanse.co.uk)

PND 3.5/20 S

PNC 11/11 S

PND 3.5/20 Z

PNC 13/12 S

PND 4.0/20 S

PND 4.0/20 Z

PAG. 3

**KIT 20**

CODICE CODE	Q.TA' Q.TY
0023.22	3
0301.42	3
0303.18	3
0605.33	3
1101.A4	3

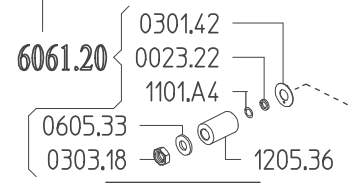
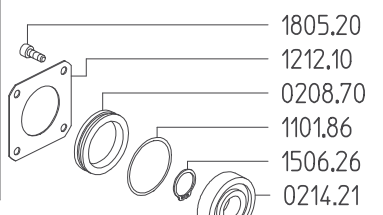

**KIT 8**

CODICE CODE	Q.TA' Q.TY
0021.11	3
0021.12	3
0307.17	3
1101.A7	3
1412.05	3

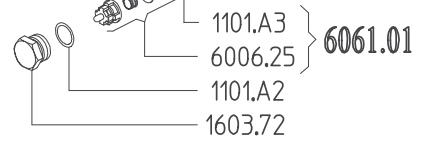
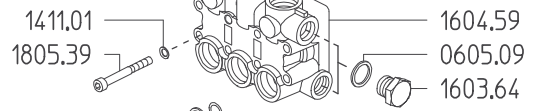
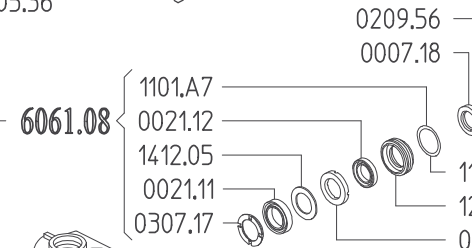

**KIT 1**

CODICE CODE	Q.TA' Q.TY
1101.A3	6
6006.25	6

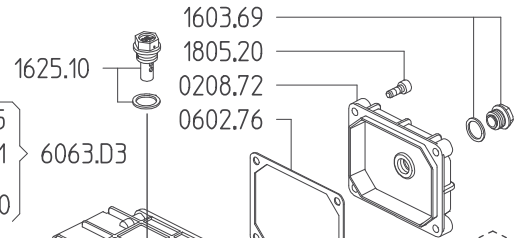

**KIT 14**

CODICE CODE	Q.TA' Q.TY
0023.26	3
1101.A7	3
1221.12	3

0031.35	PNC 11/11 S
0031.36	PND 3,5/20 S
0031.36	PNC 13/12 S
0031.36	PND 4,0/20 S

Versione VALVOLA REGOLAZIONE con DOSATORE  
UNLOADER with INJECTOR Version

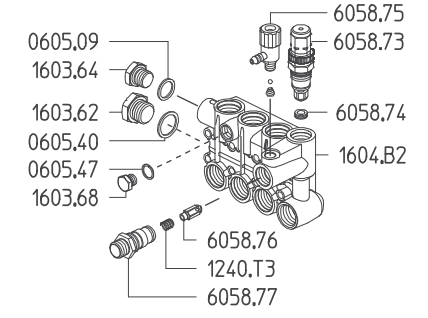

0031.44	PND 3,5/20 Z
0031.45	PND 4,0/20 Z

